

DS-2TP21B-6AVF/W

Temperature Screening Handheld Thermography Camera



The temperature screening handheld thermography camera, specially designed for surface temperature measurement. The 3.5-inch touch screen displays picture in picture of optical and thermal view, fusion of both channels. It helps you quickly find the exception according to accurate temperature measurement of high temperature targets in the environment.

Note that the device is not for medical use.

Key Feature

- 160 × 120 resolution (thermal), and 8 MP resolution (optical)
- DDE, 3D DNR, and adaptive AGC
- 640 × 480 resolution 3.5" LCD touch display
- Up to five hours continuous running

Function

Black Body Calibration

Device supports auto calibration and manual calibration. The Temperature accuracy can reach ± 0.3 °C (effective within half an hour for manual calibration).

Alarm

Device supports color and audio alarm if temperature is higher than the setting value.

Real-time Preview

Device supports connecting to PC by USB cable for real-time preview.

Temperature Measurement

Device supports detecting highest temperature of the scene, and alarm will be triggered if the detected temperature exceeds the alarm threshold in setting area.

Client Software Connection

Device supports connecting with Hik-Thermal APP via Wi-Fi to upload alarm triggered capture.

Device supports connecting with iVMS 4200 to view the device live view and upload alarms.

Multilanguage

Device supports 19 languages.



Specification

Model		DS-2TP21B-6AVF/W
Parameter	Temperature Screening Handheld Thermography Camera	
Thermal Module	Image sensor	Uncooled Focal Plane Arrays
	Resolution	25Hz: 160 × 120
	Pixel Pitch	17 μm
	Response waveband	8 μm to 14 μm
	NETD	< 40 mk (@ 25 °C, F#=1.0)
	Field of View	25° × 18.7°
	Focal length	6.2 mm (Manual Focus)
	IFOV	2.74 mrad
Optical Module	Aperture	F 1.1
	Picture Resolution	Configurable: 2 MP, 5 MP, 8 MP
	Video Resolution	640 × 480
	Screen	640 × 480 resolution 3.5" LCD touch display
Image Display	Palettes	Black hot, White hot, Red hot, Rainbow, Ironbow, Fusion, Rain
	Digital Zoom	Thermal: 1×, 2×, 4×
	Thermal / Optical	Thermal/Optical/Fusion image/Picture in picture
	Picture in Picture	Support Thermal View in Optical View
	Fusion	Support (Thermal View and Optical View Combined)
	Record Video	Support on-board video recording
Thermography	Rules	Max. Temperature; Min. Temperature; Center Temperature; Custom Point/Line/Area Thermography
	Range	30 °C to 45 °C
	Accuracy	±0.5 °C (±0.3 °C with black body calibration)
Battery	Battery Type	Dismountable and rechargeable Li-ion Battery
	Battery Operating Time	5 hours @ 25 °C, with Wi-Fi, and Bluetooth off. 4 hours @ 25 °C, with Wi-Fi, and Bluetooth on.
Function	Storage	Replaceable memory card (default 16 G, support up to 128 G storage)
	Photo	Thermal/Optical/Fusion image
	Video	Thermal/Optical/Fusion image
	Wi-Fi	Yes
	Text Comment	Yes
	Voice Comment	Yes
General	Language	English, Russian, Hungarian, German, Italian, Czech, Slovak, French, Polish, Dutch, Portuguese, Spanish, Romanian, Danish, Turkish, Korean, Traditional Chinese, Japanese, Arabic
	Power	5 VDC/2 A
	Power Consumption	Max. 4.5 W
	Hardware Interface	Type-C Interface
	Working Temperature	10 °C to 35 °C
	Protection level	IP54
	Drop Test Height	2 m (6.56 feet)

	Dimension	244 mm × 100 mm × 104 mm (9.6 " × 3.9 " × 4.1 ")
	Weight	With Battery: 660 g (1.45 lb) Without Battery: 511 g (1.13 lb)

Available Model

DS-2TP21B-6AVF/W

Accessory

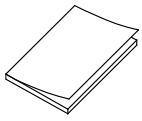

Quick Start Guide
(x1)

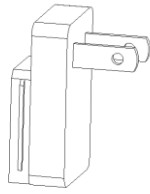

Adapter (x4)

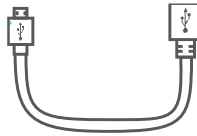

USB Cable (x1)



Power Adapter (x1)

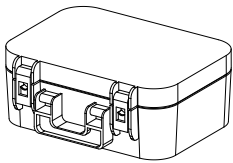

Box (x1)

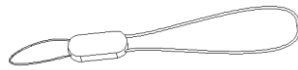

Wrist Strap (x1)

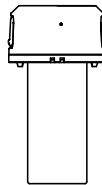

Battery (x2)

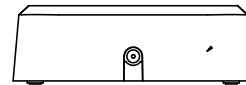

Charging Base (x1)

Dimension

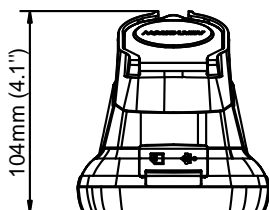
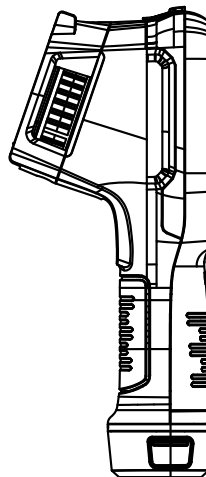
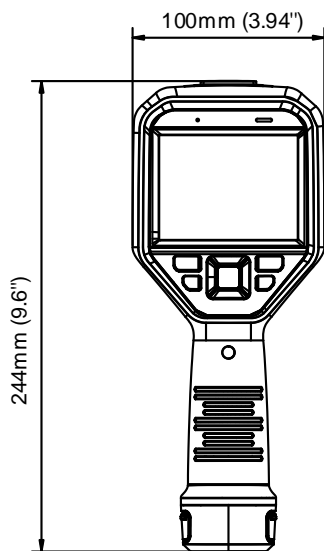

COMPLIANCE NOTICE: The thermal series products might be subject to export controls in various countries or regions, including without limitation, the United States, European Union, United Kingdom and/or other member countries of the Wassenaar Arrangement. Please consult your professional legal or compliance expert or local government authorities for any necessary export license requirements if you intend to transfer, export, re-export the thermal series products between different countries.

Distributed by



HIKVISION®

Headquarters

No.555 Qianmo Road, Binjiang District,
Hangzhou 310051, China
T +86-571-8807-5998
overseasbusiness@hikvision.com

Hikvision USA
T +1-909-895-0400
sales.usa@hikvision.com

Hikvision Australia
T +61-2-8599-4233
salesau@hikvision.com

Hikvision India
T +91-22-28469900
sales@pramahikvision.com

Hikvision Canada
T +1-866-200-6690
sales.canada@hikvision.com

Hikvision Thailand
T +662-275-9949
sales.thailand@hikvision.com

Hikvision Europe
T +31-23-5542770
sales.eu@hikvision.com

Hikvision Italy
T +39-0438-6902
info.it@hikvision.com

Hikvision Brazil
T +55 11 3318-0050
Latam.support@hikvision.com

Hikvision Turkey
T +90 [216]521 7070- 7074
sales.tr@hikvision.com

Hikvision Malaysia
T +601-7652-2413
sales.my@hikvision.com

Hikvision UK & Ireland
T +01628-902140
sales.uk@hikvision.com

Hikvision South Africa
Tel: +27 [10] 0351172
sale.africa@hikvision.com

Hikvision France
T +33[0]1-85-330-450
info.fr@hikvision.com

Hikvision Kazakhstan
T +7-727-9730667
nikia.panfilov@hikvision.ru

Hikvision Vietnam
T +84-974270888
sales.vt@hikvision.com

Hikvision UAE
T +971-4-4432090
salesme@hikvision.com

Hikvision Singapore
T +65-6684-4718
sg@hikvision.com

Hikvision Spain
T +34-91-737-16-55
info.es@hikvision.com

Hikvision Tashkent
T +99-87-1238-9438
uzb@hikvision.ru

Hikvision Hong Kong
T +852-2151-1761
info.hk@hikvision.com

Hikvision Russia
T +7-495-669-67-99
sateru@hikvision.com

Hikvision Korea
T +82-[0]31-731-8817
sales.korea@hikvision.com

Hikvision Poland
T +48-22-460-01-50
info.pl@hikvision.com

Hikvision Indonesia
T +62-21-2933759
Sales.Indonesia@hikvision.com

Hikvision Colombia
sales.colombia@hikvision.com