

## DS-2CD2183G2-I(S) 8 MP AcuSense Fixed Dome Network Camera

### AcuSense



Empowered by deep learning algorithms, Hikvision AcuSense technology brings human and vehicle targets classification alarms to front- and back-end devices. The system focuses on human and vehicle targets, vastly improving alarm efficiency and effectiveness.

- High quality imaging with 8 MP resolution
- Clear imaging against strong backlight due to 120 dB true WDR technology
- Efficient H.265+ compression technology
- Focus on human and vehicle targets classification based on deep learning
- -S: Audio and alarm interface available
- Water and dust resistant (IP67) and vandal-resistant (IK10)



## ▪ Specification

| Camera                 |  |
|------------------------|--|
| Image Sensor           | 1/2.8" Progressive Scan CMOS   |
| Min. Illumination      | Color: 0.005 Lux @ (F1.6, AGC ON), B/W: 0 Lux with IR  |
| Shutter Speed          | 1/3 s to 1/100,000 s   |
| Slow Shutter           | Yes  |
| P/N                    | P/N  |
| Wide Dynamic Range     | 120 dB   |
| Day & Night            | IR cut filter  |
| Angle Adjustment       | Pan: 0° to 355°, tilt: 0° to 75°, rotate: 0° to 355°   |
| Lens                   |  |
| Lens Type              | Fixed focal length, 2.8 and 4 mm optional  |
| Focal Length & FOV     | 2.8 mm, horizontal FOV 107°, vertical FOV 57°, diagonal FOV 128°<br>4 mm, horizontal FOV 87°, vertical FOV 46°, diagonal FOV 105°  |
| Lens Mount             | M12  |
| Iris Type              | Fixed  |
| Aperture               | F1.6   |
| DORI                   |  |
| DORI                   | 2.8 mm: D: 88 m, O: 35 m, R: 17 m, I: 9 m<br>4 mm: D: 108 m, O: 43 m, R: 22 m, I: 11 m   |
| Illuminator            |  |
| Supplement Light Type  | IR   |
| Smart Supplement Light | Yes  |
| IR Wavelength          | 850 nm   |
| IR Range               | Up to 30 m   |
| Video                  |  |
| Max. Resolution        | 3840 × 2160  |
| Main Stream            | 50 Hz: 20 fps (3840 × 2160)<br>25 fps (3200 × 1800, 2688 × 1520, 1920 × 1080, 1280 × 720)<br>60 Hz: 20 fps (3840 × 2160)<br>30 fps (3200 × 1800, 2688 × 1520, 1920 × 1080, 1280 × 720) |
| Sub Stream             | 50 Hz: 25 fps (1280 × 720, 640 × 480, 640 × 360)<br>60 Hz: 30 fps (1280 × 720, 640 × 480, 640 × 360)   |
| Third Stream           | 50 Hz: 10 fps (1920 × 1080, 1280 × 720, 640 × 480, 640 × 360)<br>60 Hz: 10 fps (1920 × 1080, 1280 × 720, 640 × 480, 640 × 360)<br>*Third stream is supported under certain settings.   |
| Video Compression      | Main stream: H.265/H.264/H.264+/H.265+<br>Sub-stream: H.265/H.264/MJPEG<br>Third stream: H.265/H.264<br>*Third stream is supported under certain settings.                             |
| Video Bit Rate         | 32 Kbps to 16 Mbps   |
| H.264 Type             | Baseline Profile/Main Profile/High Profile   |
| H.265 Type             | Main Profile   |
| H.264+                 | Main stream supports   |

|                             |  |
|-----------------------------|--|
| H.265+                      | Main stream supports   |
| Bit Rate Control            | CBR/VBR  |
| Scalable Video Coding (SVC) | H.264 and H.265 encoding   |
| Region of Interest (ROI)    | 1 fixed region for main stream and sub-stream  |
| <b>Audio</b>                |  |
| Audio Compression           | -S: G.711ulaw/G.711alaw/G.722.1/G.726/MP2L2/PCM/MP3/AAC-LC   |
| Audio Bit Rate              | -S: 64 Kbps (G.711ulaw/G.711alaw)/16 Kbps (G.722.1)/16 Kbps (G.726)/16-64 Kbps (AAC-LC)/32-192 Kbps (MP2L2)/8-320 Kbps (MP3)   |
| Audio Sampling Rate         | -S: 8 kHz/16 kHz/32 kHz/44.1 kHz/48 kHz  |
| Environment Noise Filtering | -S: Yes  |
| <b>Network</b>              |  |
| Protocols                   | TCP/IP, ICMP, HTTP, HTTPS, FTP, DHCP, DNS, DDNS, RTP, RTSP, NTP, UPnP, SMTP, IGMP, 802.1X, QoS, IPv4, IPv6, UDP, Bonjour, SSL/TLS, PPPoE, SNMP, WebSocket, WebSockets  |
| Simultaneous Live View      | Up to 6 channels   |
| API                         | Open Network Video Interface (Profile S, Profile G), ISAPI, SDK  |
| User/Host                   | Up to 32 users. 3 user levels: administrator, operator and user  |
| Security                    | Password protection, complicated password, HTTPS encryption, IP address filter, Security Audit Log, basic and digest authentication for HTTP/HTTPS, TLS 1.1/1.2, WSSE and digest authentication for Open Network Video Interface       |
| Network Storage             | NAS (NFS, SMB/CIFS), auto network replenishment (ANR)  |
| Client                      | iVMS-4200, Hik-Connect, Hik-Central  |
| Web Browser                 | Plug-in required live view: IE 10, IE 11<br>Plug-in free live view : Chrome 57.0+, Firefox 52.0+<br>Local service: Chrome 57.0+, Firefox 52.0+   |
| <b>Image</b>                |  |
| Image Parameters Switch     | Yes  |
| Image Settings              | Rotate, mirror, privacy mask, saturation, brightness, contrast, sharpness, gain, white balance adjustable by client software or web browser  |
| Day/Night Switch            | Day, Night, Auto, Schedule   |
| Image Enhancement           | BLC, HLC, 3D DNR   |
| SNR                         | ≥ 52 dB  |
| <b>Interface</b>            |  |
| Ethernet Interface          | 1 RJ45 10 M/100 M self-adaptive Ethernet port  |
| On-board Storage            | Built-in memory card slot, support microSD/SDHC/SDXC card, up to 512 GB  |
| Audio                       | -S: 1 input (line in), max. input amplitude: 3.3 Vpp, input impedance:4.7 KΩ, interface type: non-equilibrium; 1 output (line out), max.output amplitude: 3.3 Vpp, output impedance: 100 Ω, interface type: non-equilibrium,mono sound |
| Alarm                       | -S: 1 input, 1 output (max. 12 VDC, 30 mA)   |
| Hardware Reset              | Yes  |
| <b>Event</b>                |  |
| Basic Event                 | Motion detection (human and vehicle targets classification), video tampering alarm, exception  |
| Face Detection              | Yes  |

| Deep Learning Function           |   |
|----------------------------------|---|
| Perimeter Protection             | Line crossing detection, intrusion detection<br>Supports human and vehicle targets classification   |
| General                          |   |
| Linkage Method                   | Upload to FTP/memory card/NAS, notify surveillance center, trigger recording, trigger capture, send email   |
| Camera Material                  | Aluminum alloy body<br>Bubble: plastic  |
| Camera Dimension                 | Ø110.8 mm × 84.7 mm (Ø4.4" × 3.3")  |
| Package Dimension                | 134 mm × 134 mm × 108 mm (5.3" × 5.3" × 4.3")   |
| Camera Weight                    | Approx. 520 g (1.1 lb.)   |
| With Package Weight              | Approx. 720 g (1.6 lb.)   |
| Storage Conditions               | -30 °C to 60 °C (-22 °F to 140 °F). Humidity 95% or less (non-condensing)   |
| Startup and Operating Conditions | -30 °C to 60 °C (-22 °F to 140 °F). Humidity 95% or less (non-condensing)   |
| Web Client Language              | 33 languages<br>English, Russian, Estonian, Bulgarian, Hungarian, Greek, German, Italian, Czech, Slovak, French, Polish, Dutch, Portuguese, Spanish, Romanian, Danish, Swedish, Norwegian, Finnish, Croatian, Slovenian, Serbian, Turkish, Korean, Traditional Chinese, Thai, Vietnamese, Japanese, Latvian, Lithuanian, Portuguese (Brazil), Ukrainian |
| General Function                 | Anti-flicker, heartbeat, password reset via email, pixel counter  |
| Firmware Version                 | V5.5.113  |
| Software Reset                   | Yes   |
| Power Consumption and Current    | 12 VDC, 0.5 A, max. 6 W<br>PoE (802.3af, 36 V to 57 V), 0.25 A to 0.15 A, max. 7.5 W  |
| Power Supply                     | 12 VDC ± 25%, reverse polarity protection<br>PoE: 802.3af, Class 3  |
| Power Interface                  | Ø5.5 mm coaxial power plug  |
| Approval                         |   |
| EMC                              | FCC (47 CFR Part 15, Subpart B); CE-EMC (EN 55032: 2015, EN 61000-3-2: 2014, EN 61000-3-3: 2013, EN 50130-4: 2011 +A1: 2014); RCM (AS/NZS CISPR 32: 2015); IC (ICES-003: Issue 6, 2016); KC (KN 32: 2015, KN 35: 2015)  |
| Safety                           | UL (UL 60950-1); CB (IEC 60950-1:2005 + Am 1:2009 + Am 2:2013); CE-LVD (EN 60950-1:2005 + Am 1:2009 + Am 2:2013);   |
| Environment                      | CE-RoHS (2011/65/EU); WEEE (2012/19/EU); Reach (Regulation (EC) No 1907/2006)   |
| Protection                       | IP67 (IEC 60529-2013), IK10 (IEC 62262: 2002)   |

### ▪ Available Model

DS-2CD2183G2-I (2.8/4 mm)

DS-2CD2183G2-IS (2.8/4 mm)

DS-2CD2183G2-IS (2.8 mm) (Black)

### ▪ Typical Application

Hikvision products are classified into three levels according to their anti-corrosion performance. Refer to the following description to choose for your using environment.

This model has NO SPECIFIC PROTECTION.

| Level                  | Description  |
|------------------------|--|
| Top-level protection   | Hikvision products at this level are equipped for use in areas where professional anti-corrosion protection is a must. Typical application scenarios include coastlines, docks, chemical plants, and more.   |
| Moderate protection    | Hikvision products at this level are equipped for use in areas with moderate anti-corrosion demands. Typical application scenarios include coastal areas about 2 kilometers (1.24 miles) away from coastlines, as well as areas affected by acid rain. |
| No specific protection | Hikvision products at this level are equipped for use in areas where no specific anti-corrosion protection is needed.  |



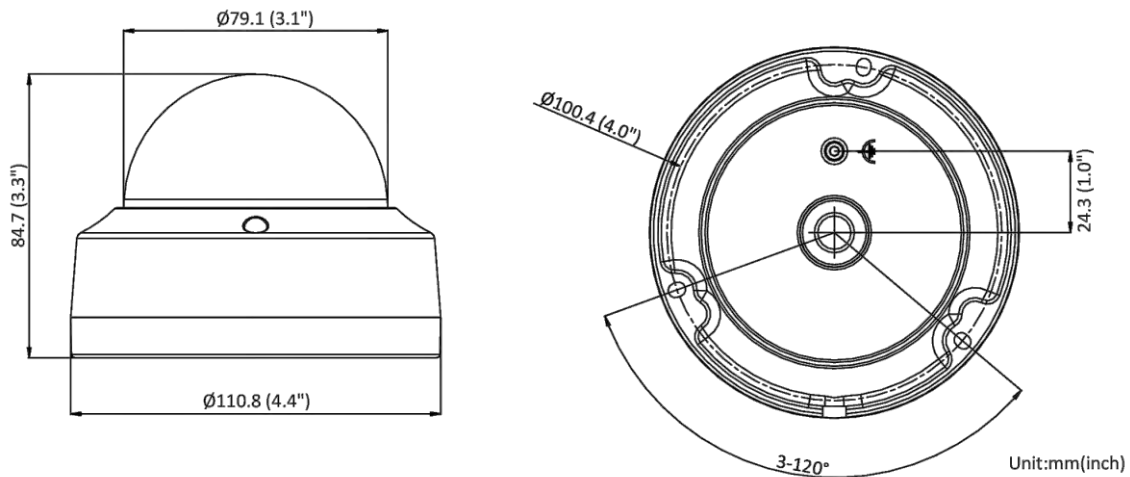







### Dimension



### Accessory

#### Optional

| DS-1271ZJ-110<br>(Black)<br>Pendant Mount | DS-1259ZJ(Black)<br>Junction Box | DS-1275ZJ-SUS<br>Vertical Pole Mount | DS-1250ZJ<br>Rain Shade | DS-1272ZJ-110<br>(Black)<br>Wall Mount |
|---|----------------------------------|--------------------------------------|-------------------------|--|
|   |                                  |                                      |                         |  |

|   |  |  |  |  |
|---|--|--|--|--|
| <p><b>DS-1280ZJ-DM18</b><br/>Junction box</p>                                       | <p><b>DS-1272ZJ-110B</b><br/>(Black)<br/>Wall Mount</p>                            | <p><b>DS-1276ZJ-SUS</b><br/>Corner mount</p>                                       | <p><b>DS-1276ZJ-SUS</b><br/>(Black)<br/>Corner Mount</p>                             | <p><b>DS-1259ZJ</b><br/>Inclined Ceiling<br/>Mount</p>                               |
|    |   |   |   |   |
| <p><b>DS-1272ZJ-110B</b><br/>Wall Mount</p>   | <p><b>DS-1271ZJ-110</b><br/>Pendant Mount</p>                                      | <p><b>DS-1272ZJ-110</b><br/>Wall Mount</p>   | <p><b>DS-1275ZJ-SUS</b><br/>(Black)<br/>Vertical Pole Mount</p>                      | <p><b>DS-1280ZJ-DM18</b><br/>(Black)<br/>Junction Box</p>                            |
|   |  |  |  |  |
| <p><b>DS-1250ZJ(Black)</b><br/>Rain Shade</p>                                       |  |  |  |  |
|  |  |  |  |  |

Distributed by

**HIKVISION****Headquarters**

No.555 Qianmo Road, Binjiang District,  
Hangzhou 310051, China  
T +86-571-8807-5998  
overseasbusiness@hikvision.com

**Hikvision USA**  
T +1-909-895-0400  
sales.usa@hikvision.com

**Hikvision Australia**  
T +61-2-8599-4233  
salesau@hikvision.com

**Hikvision India**  
T +91-22-28469900  
sales@pramahikvision.com

**Hikvision Canada**  
T +1-866-200-6690  
sales.canada@hikvision.com

**Hikvision Thailand**  
T +662-275-9949  
sales.thailand@hikvision.com

**Hikvision Europe**  
T +31-23-5542770  
sales.eu@hikvision.com

**Hikvision Italy**  
T +39-0438-6902  
info.it@hikvision.com

**Hikvision Brazil**  
T +55 11 3318-0050  
Latam.support@hikvision.com

**Hikvision Turkey**  
T +90 [216]521 7070- 7074  
sales.tr@hikvision.com

**Hikvision Malaysia**  
T +601-7652-2413  
sales.my@hikvision.com

**Hikvision UK & Ireland**  
T +01628-902140  
sales.uk@hikvision.com

**Hikvision South Africa**  
Tel: +27 (10) 0351172  
sale.africa@hikvision.com

**Hikvision France**  
T +33(0)1-85-330-450  
info.fr@hikvision.com

**Hikvision Kazakhstan**  
T +7-727-9730667  
nikia.panfilov@hikvision.ru

**Hikvision Vietnam**  
T +84-974270888  
sales.vt@hikvision.com

**Hikvision UAE**  
T +971-4-4432090  
salesme@hikvision.com

**Hikvision Singapore**  
T +65-6684-4718  
sg@hikvision.com

**Hikvision Spain**  
T +34-91-737-16-55  
info.es@hikvision.com

**Hikvision Tashkent**  
T +99-87-1238-9438  
uzb@hikvision.ru

**Hikvision Hong Kong**  
T +852-2151-1761  
info.hk@hikvision.com

**Hikvision Russia**  
T +7-495-669-67-99  
saleru@hikvision.com

**Hikvision Korea**  
T +82-(0)31-731-8817  
sales.korea@hikvision.com

**Hikvision Poland**  
T +48-22-460-01-50  
info.pl@hikvision.com

**Hikvision Indonesia**  
T +62-21-2933759  
Sales.Indonesia@hikvision.com

**Hikvision Colombia**  
sales.colombia@hikvision.com