

## DS-2CE79U1T-IT3ZF 8 MP Turret Camera

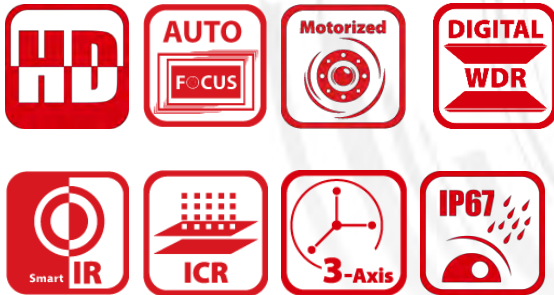

### Key Features

- 8.29 MP high performance CMOS
- Auto focus
- 3840 × 2160 resolution
- 2.7 mm to 13.5 mm motorized vari-focal lens
- EXIR 2.0, smart IR, up to 60 m IR distance
- OSD menu, DNR
- 4 in 1 video output (switchable TVI/AHD/CVI/CVBS)
- IP67
- Up the coax (HIKVISION-C)



| <b>Camera</b>                     |   |
|-----------------------------------|---|
| Image Sensor                      | 8.29 megapixel progressive scan CMOS  |
| Frame Rate                        | TVI: 8MP@12.5fps, 8MP@15fps, 5MP@20fps, 4MP@25fps, 4MP@30fps, 2MP@25fps, 2MP@30fps<br>CVI: 8MP@12.5fps, 8MP@15fps<br>AHD: 5MP@20fps<br>CVBS: 960H P/N |
| Resolution                        | 3840 (H) × 2160 (V)   |
| Min. illumination                 | Color: 0.01 Lux @ (F1.2, AGC ON), 0 Lux with IR   |
| Shutter Time                      | PAL: 1/12.5s to 1/50,000 s<br>NTSC: 1/15 s to 1/50,000 s  |
| Lens                              | 2.7 mm to 13.5 mm motorized vari-focal lens   |
| Horizontal Field of View          | 108.1° to 45.6°   |
| Lens Mount                        | Φ 14  |
| Day & Night                       | IR cut filter   |
| Angle Adjustment                  | Pan: 0° to 360°; Tilt: 0° to 75°; Rotate: 0° to 360°  |
| Synchronization                   | Internal synchronization  |
| DWDR (Digital Wide Dynamic Range) | 105 dB  |
| <b>Menu</b>                       |   |
| AGC                               | Yes   |
| D/N Mode                          | Auto/Color/BW (Black and White)   |
| White Balance                     | Auto/Manual   |
| BLC                               | Yes   |
| DWDR (Digital Wide Dynamic Range) | Yes   |
| Functions                         | Brightness, Sharpness, DNR, Mirror, Smart IR  |
| <b>Interface</b>                  |   |
| Video Output                      | 1 HD analog output  |
| Switch Button                     | TVI/AHD/CVI/CVBS  |
| <b>General</b>                    |   |
| Operating Conditions              | -40 °C to 60 °C (-40 °F to 140 °F), humidity: 90% or less (non-condensation)  |
| Power Supply                      | 9 VDC to 15 VDC   |
| Power Consumption                 | Max. 8.6W   |
| Protection Level                  | IP67  |
| Material                          | Metal   |
| IR Range                          | Up to 60 m  |
| Communication                     | Up the coax, Protocol: HIKVISION-C (TVI output)   |
| Dimensions                        | 134.3 mm × 123.86 mm × 110.24 mm (5.29" × 4.88" × 4.34")  |
| Weight                            | Approx. 580 g (1.28 lb.)  |

**Order Model**

DS-2CE79U1T-IT3ZF

**Dimension**

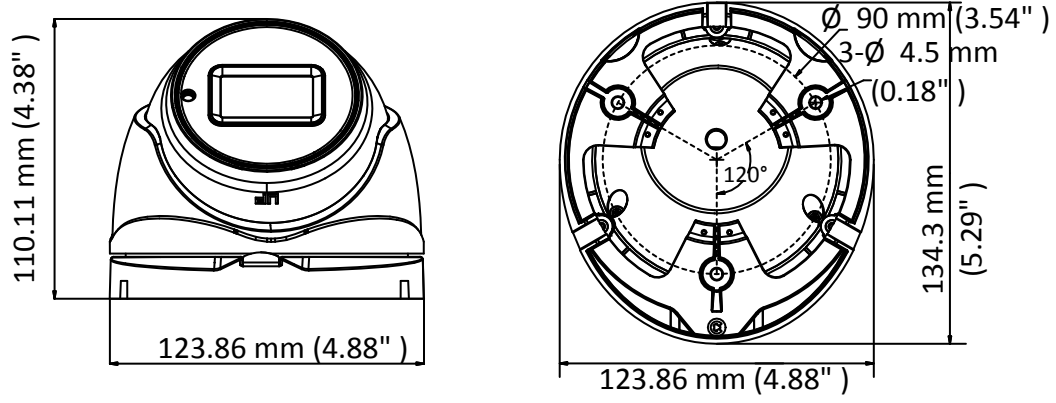

## Accessory



**DS-1273ZJ-130-TRL**  
Wall Mount



**DS-1275ZJ-SUS**  
Vertical Pole Mount



**DS-1276ZJ-SUS**  
Corner Mount



**DS-1280ZJ-M**  
Junction Box

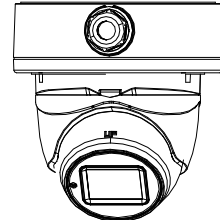
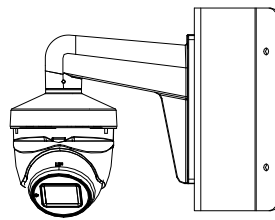
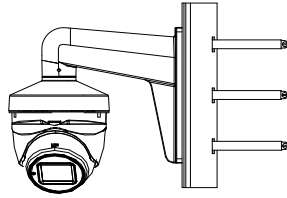
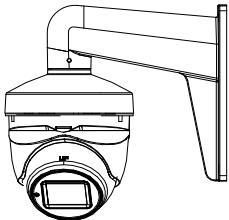

**DS-1281ZJ-M**  
Inclined Ceiling Mount

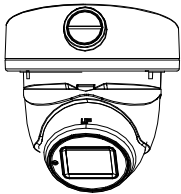

Distributed by



## HIKVISION™

### Headquarters

No.555 Qianmo Road, Binjiang District,  
Hangzhou 310051, China  
T +86-571-8807-5998  
overseasbusiness@hikvision.com

**Hikvision USA**  
T +1-909-895-0400  
sales.usa@hikvision.com

**Hikvision Europe**  
T +31-23-55-42-770  
info.eu@hikvision.com

**Hikvision Middle East**  
T +971-4-8816086  
salesme@hikvision.com

**Hikvision Russia**  
T +7-495-669-67-99  
saleru@hikvision.com

**Hikvision India**  
T +91-22-28469900  
sales@pramahikvision.com

**Hikvision Italy**  
T +39-0438-6902  
info.it@hikvision.com

**Hikvision France**  
T +33(0)1-85-330-450  
info.fr@hikvision.com

**Hikvision Spain**  
T +34-91-737-16-55  
info.es@hikvision.com

**Hikvision Poland**  
T +48-22-460-01-50  
poland@hikvision.com

**Hikvision UK**  
T +01628-902140  
support.uk@hikvision.com

**Hikvision Singapore**  
T +65-6684-4718  
sg@hikvision.com

**Hikvision Oceania**  
T +61-2-8599-4233  
salesau@hikvision.com

**Hikvision Canada**  
T +1-909-895-0400  
sales.usa@hikvision.com

**Hikvision Korea**  
T +82-31-731-8841  
sales.korea@hikvision.com

**Hikvision Brazil**  
T +55 11 3318-0050  
Latam.support@hikvision.com

**Hikvision Africa**  
T +27 (10) 0351172  
sale.africa@hikvision.com

**Hikvision Hong Kong**  
T +852-2151-1761